



P U B L I C A T I O N T R A N S M I T T A L

The technical content of this document is approved under the authority of the DOA ref. EASA.21J.065.

Date Apr.12/22

BR700 SERIES PROPULSION SYSTEM SERVICE BULLETIN

ALERT

Export Control Rating: This technical information/software is not controlled under the German export control regulations.

This document transmits the Initial Issue of Non-Modification Service Bulletin SB-BR700-72-A900726.

This Non-Modification Service Bulletin can be embodied "In Service".

Non-Modification Service Bulletin Initial Issue

Remove	Incorporate	Reason for change
	Pages 1 to 33 of the Non-Modification Service Bulletin.	Initial Issue.

ALERT SB-BR700-72-A900726

Transmittal - Page 1 of 1



BR700 Series

SERVICE
BULLETIN

ENGINE - HIGH PRESSURE (HP) COMPRESSOR FRONT CASE - REPEAT BORESCOPE INSPECTION OF
THE HP COMPRESSOR STAGES 1 TO 4 FRONT CASE LINING - NON-MODIFICATION SERVICE
BULLETIN

1. Planning Information

A. Effectivity

BR700-725A1-12 Engines.

For Engine Serial Numbers 25453 and 25454.

Module M33-126 (HP Compressor Module).

B. Concurrent Requirements

None.

C. Reason

The High Pressure (HP) compressor front case and the HP compressor rotor drum are equipped with abradable lining material. This technology makes sure that an optimum HP compressor performance is achieved by giving minimum tip clearances between the rotor blade tips and the HP compressor front case and the stator vane tips and the HP compressor rotor drum.

This Non-Modification Service Bulletin is raised to examine the condition of the HP compressor stages 1 to 4 front case lining material, on engines which have been identified to be potentially affected by HP compressor front case lining material deterioration.

D. Description

SAFETY INTENT: The safety intent of this Non-Modification Service Bulletin is to reduce the risk of a multiple-engine in-flight shutdown by a repeat borescope inspection of the HP compressor stages 1 to 4 front case lining at a specified interval.

This Non-Modification Service Bulletin instructs a borescope inspection of the HP compressor stages 1 to 4 front case lining for indications of missing lining material.

NOTE: The borescope inspection of the HP compressor stages 1 to 4 front case lining must be done by BR700 engine family experienced/trained personnel only.

Service experience has identified different types of HP compressor stages 1 to 4 front case lining conditions, which are:

(1) **NORMAL LINER CONDITION:** No damages to the liner surface, no breakouts and no liner loss (Refer to typical view on Figure 2, Sheet 7).



BR700 Series

SERVICE
BULLETIN

- (2) RUBBED CONDITION: Slight longitudinal grooves in circumferential direction at the liner surface only (Refer to typical view on Figure 3, Sheet 1).
- (3) LOCAL SURFACE CHIPPING/PITTING: Local notches, cavities or other impacts at the liner surface only (Refer to typical view on Figure 3, Sheet 2).
- (4) LOCAL SURFACE BREAKOUT: Local liner material loss deeper below the liner surface, but not down to the case material at the bottom of the liner pocket (Refer to typical view on Figure 3, Sheet 2).
- (5) PARTIAL LINER LOSS: Liner material loss down to the case material at the bottom of the liner pocket, but not over the complete liner pocket width from front to rear (Refer to typical view on Figure 3, Sheet 3).
- (6) COMPLETE LINER LOSS: Liner material loss down to the case material at the bottom of the liner pocket, over the complete liner pocket width from front to rear (Refer to typical view on Figure 3, Sheet 4).
- (7) OPEN SPLIT LINE CONDITION: Liner material detachment between the liner and the case in circumferential direction, also with liner lifting and with partially rubbing at the lifted liner (Refer to typical view on Figure 3, Sheet 5).
- (8) OPEN SPLIT LINE (CRACKING) AT HALF CASE SPLIT LINE: Liner material detachment between the liner and the case at the half case split line, also with liner lifting and with partially rubbing at the lifted liner (Refer to typical view on Figure 3, Sheet 6).

Printed in Great Britain

E. Compliance

ALERT

This Non-Modification Service Bulletin must be accomplished on all engines before the engine has accumulated 848 flight cycles since new or by 10th September 2022, whichever occurs first.

This Non-Modification Service Bulletin must be accomplished again at intervals of not more than 25 flight cycles after the previous accomplishment.

F. Approval

The technical content of this document is approved under the authority of the DOA ref. EASA.21J.065.



BR700 Series

SERVICE
BULLETIN

G. Manpower

Estimated Man-hours:

(1) In Service

7,5 hours.

(2) At Overhaul/Shop Visit

Not applicable.

H. Material Price and Availability

Not applicable.

I. Tooling Price and Availability

New tools are not required.

J. Industry Support Information

The incorporation of this Non-Modification Service Bulletin is not free of charge.

K. Weight and Balance

(1) Weight Change

None.

(2) Moment Arm

No effect.

(3) Datum

ES2540 (PPS100).

L. Electrical Load Data

The aircraft electrical load is not affected by this Non-Modification Service Bulletin.

M. Software Accomplishment Summary

Not applicable.



BR700 Series

SERVICE
BULLETIN

N. References

(1) Aircraft Maintenance Manual, Chapters 71-10-00, 72-00-00, 72-03-01 and 72-71-02.

O. Other Publications Affected

None.

P. Interchangeability of Parts

Not affected.

Printed in Great Britain



BR700 Series

SERVICE
BULLETIN

2. Material Information

A. Parts to be Replaced

None.

B. Expendable Parts

Refer to the related Manual tasks given in the Accomplishment Instruction of this Non-Modification Service Bulletin.

NOTE: To get sufficient access for the borescope inspection of the HP compressor stages 1 to 4 front case lining, the HP compressor stages 1 to 4 Variable Stator Vanes (VSV) must be moved into a position to allow free access through the borescope access ports towards the area to be inspected. After completion of this task, a drain plug with a related seal ring must be re-installed to a fuel tube to safely seal the engine fuel system. To enable this, an expendable seal ring must be ordered as instructed in the Aircraft Maintenance Manual, Chapter 72-00-00, PB601 and in the Engine Manual, Chapter 72-00-00, PB801/TASK 72-00-00-200-801.

C. Instruction/Disposition Codes

None.



BR700 Series

SERVICE
BULLETIN

3. Accomplishment Instruction

A. General

NOTE: When the words "refer to" are used in the Accomplishment Instruction and there are other acceptable methods, techniques and practices (including tools, equipment and test equipment) those acceptable methods, techniques and practices (including tools, equipment and test equipment) can be used to complete the work, however Rolls-Royce Deutschland always recommends to use the procedures referred to in the Accomplishment Instruction. When the words "in accordance with" are used in the Accomplishment Instruction, the methods, techniques and practices (including tools, equipment and test equipment) in the specified document must be used.

NOTE: In order to reduce the potential for multiple-engine in-flight shutdown, power loss, or other anomaly due to maintenance error, Rolls-Royce Deutschland recommends that Operators avoid performing maintenance on multiple engines installed on the same aircraft at the same time. If it is not possible to avoid maintenance on more than one engine of an aircraft at the same time, Rolls-Royce Deutschland recommends that additional controls are applied in order to ensure that maintenance tasks have been completed as defined.

WARNING: YOU MUST BE CAREFUL WHEN YOU DO WORK ON THE ENGINE PARTS AFTER THE ENGINE IS STOPPED. THE ENGINE PARTS CAN STAY HOT FOR ALMOST ONE HOUR.

WARNING: DO NOT TOUCH HOT PARTS WITHOUT APPLICABLE GLOVES. HOT PARTS CAN CAUSE AN INJURY. IF YOU GET AN INJURY, PUT IT IN COLD WATER FOR TEN MINUTES AND GET MEDICAL AID.

(1) Obey all the WARNINGS and CAUTIONS in the procedures that are referred to.

(2) Consumable Materials

(a) Refer to the related Manual tasks given in this instruction.

Printed in Great Britain



BR700 Series

SERVICE
BULLETIN

(3) Tools and Equipment

(a) Refer to the table that follows:

REFERENCE	DESIGNATION
No Specific	Flexible video-borescope with a 6,0 to 6,5 mm (0.24 to 0.26 in.) diameter and a minimum length of 2 meters (6.56 ft) (a length of 3 meters (9.84 ft) is recommended). Tip adapters - straight view.

(b) For further tools and equipment refer also to the related Manual tasks given in this instruction.

B. Get access to the borescope access ports B, C and D on the core engine (Refer to the Figures 1 and 2)

- (1) Open the applicable cowl doors (Refer to the Aircraft Maintenance Manual, Chapter 71-10-00, PB201).
- (2) Remove the applicable bypass duct access panels from the engine (Refer to the Aircraft Maintenance Manual, Chapter 72-71-02, PB401).
- (3) Remove the applicable High Pressure (HP) compressor fairings from the core engine (Refer to the Aircraft Maintenance Manual, Chapter 72-03-01, PB401).

C. Examine the HP compressor stages 1 to 4 front case lining for damages (Refer to the Aircraft Maintenance Manual, Chapter 72-00-00, PB601 and to the steps C.(1) to C.(6) and Figures 1 to 3 of this Non-Modification Service Bulletin)

(1) At Detail D:

- (a) Insert a 6,0 to 6,5 mm (0.24 to 0.26 in.) diameter flexible video-borescope through the borescope access port B.
- (b) If necessary, adjust the HP compressor stages 1 to 4 Variable Stator Vanes (VSV), as instructed in the Aircraft Maintenance Manual, Chapter 72-00-00, PB601, into a position to allow free access through the borescope access port B for the inspection of the HP compressor stages 1 front case lining.
- (c) In between the HP compressor stage 1 rotor blades (Trailing/Edge (T/E)) and the HP compressor stage 1 stator vanes (Leading/Edge (L/E)), push the tip adapter of the flexible video-borescope a full rotation (360 degrees) around the HP compressor rotor drum until the tip adapter reaches the point where it was inserted.

NOTE: The HP compressor stage 1 rotor blades have blade snubbers, if blade snubbers are visible, the tip adapter of the flexible video-borescope is at the correct position.

Printed in Great Britain



BR700 Series

SERVICE
BULLETIN

(d) Visually examine the HP compressor stage 1 front case lining from the rear by slowly pulling the flexible video-borescope backwards until the full circumference is inspected (Refer to Figures 2 and 3)

[1] Do a video-record of the complete HP compressor stage 1 front case lining inspection.

[2] Record normal condition, rubbed condition, local surface chipping/pitting, local surface breakout, partial/complete liner loss and/or open circumferential split line condition in the applicable columns of Table 1 in the Accomplishment Form on page 31.

[3] Record open split line (cracking) at the half case split lines in the applicable columns of Table 5 in the Accomplishment Form on page 33.

[4] If local surface breakout, partial liner loss or complete liner loss is found, count the number of affected blade sectors in between local surface breakout, partial liner loss and complete liner loss was found. This is to allow later calculation of the actual percentage of local surface breakout, partial liner loss and complete liner loss on the HP compressor stage 1 front case liner

NOTE: A blade sector is the area in between two adjacent rotor blade tips (Refer to Figure 2, Sheet 3 or 6).

[a] Record the amount of affected blade sectors in the applicable columns of the Tables 2, 3 and 4 in the Accomplishment Form on page 32.

(2) At Detail E:

(a) Insert a 6,0 to 6,5 mm (0.24 to 0.26 in.) diameter flexible video-borescope through the borescope access port B.

(b) If necessary, adjust the HP compressor stages 1 to 4 VSVs, as instructed in the Aircraft Maintenance Manual, Chapter 72-00-00, PB601, into a position to allow free access through the borescope access port B for the inspection of the HP compressor stages 2 front case lining.

(c) In between the HP compressor stage 1 stator vanes (T/E) and the HP compressor stage 2 rotor blades (L/E), push the tip adapter of the flexible video-borescope a full rotation (360 degrees) around the HP compressor rotor drum until the tip adapter reaches the point where it was inserted.

Printed in Great Britain



BR700 Series

SERVICE
BULLETIN

Printed in Great Britain

- (d) Visually examine the HP compressor stage 2 front case lining from the front by slowly pulling the flexible video-borescope backwards until the full circumference is inspected (Refer to Figures 2 and 3)
- [1] Do a video-record of the complete HP compressor stage 2 front case lining inspection.
 - [2] Record normal condition, rubbed condition, local surface chipping/pitting, local surface breakout, partial/complete liner loss and/or open circumferential split line condition in the applicable columns of Table 1 in the Accomplishment Form on page 31.
 - [3] Record open split line (cracking) at the half case split lines in the applicable columns of Table 5 in the Accomplishment Form on page 33.
 - [4] If local surface breakout, partial liner loss or complete liner loss is found, count the number of affected blade sectors in between local surface breakout, partial liner loss and complete liner loss was found. This is to allow later calculation of the actual percentage of local surface breakout, partial liner loss and complete liner loss on the HP compressor stage 2 front case liner

NOTE: A blade sector is the area in between two adjacent rotor blade tips (Refer to Figure 2, Sheet 3 or 6).

- [a] Record the amount of affected blade sectors in the applicable columns of the Tables 2, 3 and 4 in the Accomplishment Form on page 32.

(3) At Detail E:

- (a) Insert a 6,0 to 6,5 mm (0.24 to 0.26 in.) diameter flexible video-borescope through the borescope access port C.
- (b) If necessary, adjust the HP compressor stages 1 to 4 VSVs, as instructed in the Aircraft Maintenance Manual, Chapter 72-00-00, PB601, into a position to allow free access through the borescope access port C for the inspection of the HP compressor stages 2 front case lining.
- (c) In between the HP compressor stage 2 rotor blades (T/E) and the HP compressor stage 2 stator vanes (L/E), push the tip adapter of the flexible video-borescope a full rotation (360 degrees) around the HP compressor rotor drum until the tip adapter reaches the point where it was inserted.



BR700 Series

SERVICE
BULLETIN

(d) Visually examine the HP compressor stage 2 front case lining from the rear by slowly pulling the flexible video-borescope backwards until the full circumference is inspected (Refer to Figures 2 and 3)

[1] Do a video-record of the complete HP compressor stage 2 front case lining inspection.

[2] Record normal condition, rubbed condition, local surface chipping/pitting, local surface breakout, partial/complete liner loss and/or open circumferential split line condition in the applicable columns of Table 1 in the Accomplishment Form on page 31.

[3] Record open split line (cracking) at the half case split lines in the applicable columns of Table 5 in the Accomplishment Form on page 33.

[4] If local surface breakout, partial liner loss or complete liner loss is found, count the number of affected blade sectors in between local surface breakout, partial liner loss and complete liner loss was found. This is to allow later calculation of the actual percentage of local surface breakout, partial liner loss and complete liner loss on the HP compressor stage 2 front case liner

NOTE: A blade sector is the area in between two adjacent rotor blade tips (Refer to Figure 2, Sheet 3 or 6).

[a] Record the amount of affected blade sectors in the applicable columns of the Tables 2, 3 and 4 in the Accomplishment Form on page 32.

(4) At Detail F:

(a) Insert a 6,0 to 6,5 mm (0.24 to 0.26 in.) diameter flexible video-borescope through the borescope access port C.

(b) If necessary, adjust the HP compressor stages 1 to 4 VSVs, as instructed in the Aircraft Maintenance Manual, Chapter 72-00-00, PB601, into a position to allow free access through the borescope access port C for the inspection of the HP compressor stages 3 front case lining.

(c) In between the HP compressor stage 2 stator vanes (T/E) and the HP compressor stage 3 rotor blades (L/E), push the tip adapter of the flexible video-borescope a full rotation (360 degrees) around the HP compressor rotor drum until the tip adapter reaches the point where it was inserted.

Printed in Great Britain



BR700 Series

SERVICE
BULLETIN

- (d) Visually examine the HP compressor stage 3 front case lining from the front by slowly pulling the flexible video-borescope backwards until the full circumference is inspected (Refer to Figures 2 and 3)
- [1] Do a video-record of the complete HP compressor stage 3 front case lining inspection.
 - [2] Record normal condition, rubbed condition, local surface chipping/pitting, local surface breakout, partial/complete liner loss and/or open circumferential split line condition in the applicable columns of Table 1 in the Accomplishment Form on page 31.
 - [3] Record open split line (cracking) at the half case split lines in the applicable columns of Table 5 in the Accomplishment Form on page 33.
 - [4] If local surface breakout, partial liner loss or complete liner loss is found, count the number of affected blade sectors in between local surface breakout, partial liner loss and complete liner loss was found. This is to allow later calculation of the actual percentage of local surface breakout, partial liner loss and complete liner loss on the HP compressor stage 3 front case liner

NOTE: A blade sector is the area in between two adjacent rotor blade tips (Refer to Figure 2, Sheet 3 or 6).

- [a] Record the amount of affected blade sectors in the applicable columns of the Tables 2, 3 and 4 in the Accomplishment Form on page 32.

(5) At Detail F:

- (a) Insert a 6,0 to 6,5 mm (0.24 to 0.26 in.) diameter flexible video-borescope through the borescope access port D.
- (b) If necessary, adjust the HP compressor stages 1 to 4 VSVs, as instructed in the Aircraft Maintenance Manual, Chapter 72-00-00, PB601, into a position to allow free access through the borescope access port D for the inspection of the HP compressor stages 3 front case lining.
- (c) In between the HP compressor stage 3 rotor blades (T/E) and the HP compressor stage 3 stator vanes (L/E), push the tip adapter of the flexible video-borescope a full rotation (360 degrees) around the HP compressor rotor drum until the tip adapter reaches the point where it was inserted.



BR700 Series

SERVICE
BULLETIN

(d) Visually examine the HP compressor stage 3 front case lining from the rear by slowly pulling the flexible video-borescope backwards until the full circumference is inspected (Refer to Figures 2 and 3)

[1] Do a video-record of the complete HP compressor stage 3 front case lining inspection.

[2] Record normal condition, rubbed condition, local surface chipping/pitting, local surface breakout, partial/complete liner loss and/or open circumferential split line condition in the applicable columns of Table 1 in the Accomplishment Form on page 31.

[3] Record open split line (cracking) at the half case split lines in the applicable columns of Table 5 in the Accomplishment Form on page 33.

[4] If local surface breakout, partial liner loss or complete liner loss is found, count the number of affected blade sectors in between local surface breakout, partial liner loss and complete liner loss was found. This is to allow later calculation of the actual percentage of local surface breakout, partial liner loss and complete liner loss on the HP compressor stage 3 front case liner

NOTE: A blade sector is the area in between two adjacent rotor blade tips (Refer to Figure 2, Sheet 3 or 6).

[a] Record the amount of affected blade sectors in the applicable columns of the Tables 2, 3 and 4 in the Accomplishment Form on page 32.

(6) At Detail G:

(a) Insert a 6,0 to 6,5 mm (0.24 to 0.26 in.) diameter flexible video-borescope through the borescope access port D.

(b) If necessary, adjust the HP compressor stages 1 to 4 VSVs, as instructed in the Aircraft Maintenance Manual, Chapter 72-00-00, PB601, into a position to allow free access through the borescope access port D for the inspection of the HP compressor stages 4 front case lining.

(c) In between the HP compressor stage 3 stator vanes (T/E) and the HP compressor stage 4 rotor blades (L/E), push the tip adapter of the flexible video-borescope a full rotation (360 degrees) around the HP compressor rotor drum until the tip adapter reaches the point where it was inserted.

Printed in Great Britain



BR700 Series

SERVICE
BULLETIN

Printed in Great Britain

- (d) Visually examine the HP compressor stage 4 front case lining from the front by slowly pulling the flexible video-borescope backwards until the full circumference is inspected (Refer to Figures 2 and 3)
- [1] Do a video-record of the complete HP compressor stage 4 front case lining inspection.
 - [2] Record normal condition, rubbed condition, local surface chipping/pitting, local surface breakout, partial/complete liner loss and/or open circumferential split line condition in the applicable columns of Table 1 in the Accomplishment Form on page 31.
 - [3] Record open split line (cracking) at the half case split lines in the applicable columns of Table 5 in the Accomplishment Form on page 33.
 - [4] If local surface breakout, partial liner loss or complete liner loss is found, count the number of affected blade sectors in between local surface breakout, partial liner loss and complete liner loss was found. This is to allow later calculation of the actual percentage of local surface breakout, partial liner loss and complete liner loss on the HP compressor stage 4 front case liner

NOTE: A blade sector is the area in between two adjacent rotor blade tips (Refer to Figure 2, Sheet 3 or 6).

- [a] Record the amount of affected blade sectors in the applicable columns of the Tables 2, 3 and 4 in the Accomplishment Form on page 32.

D. Calculation and evaluation of the inspection or re-inspection results (use the Tables 1 to 5 in the Accomplishment Form on the pages 31 to 33):

- (1) If local surface breakout was found, calculate the actual percentage of local surface breakout, which was found on the HP compressor stages 1 to 4 front case liners (use Table 2).
- (2) If partial liner loss was found, calculate the actual percentage of partial liner loss, which was found on the HP compressor stages 1 to 4 front case liners (use Table 3).
- (3) If complete liner loss was found, calculate the actual percentage of complete liner loss, which was found on the HP compressor stages 1 to 4 front case liners (use Table 4).



BR700 Series

SERVICE
BULLETIN

- (4) Complete the evaluation based on the inspection or re-inspection results (use the Tables 1 to 5 as required)
- (a) If normal condition (described in Figure 2, Sheet 7), rubbed condition (described in Figure 3, Sheet 1) and/or local surface chipping/pitting (described in Figure 3, Sheet 2) was found on stages 1 to 4, accept and do the borescope inspection in accordance with this Non-Modification Service Bulletin again, at intervals of not more than 25 flight cycles after the previous accomplishment.
- (b) If local surface breakout (described in Figure 3, Sheet 2) was found on stages 1 to 4:
- [1] If up to 9,7 percent (three affected blade sectors) of local surface breakout was found on stages 1, accept and do the borescope inspection in accordance with this Non-Modification Service Bulletin again, at intervals of not more than 25 flight cycles after the previous accomplishment.
- [2] If up to 8,1 percent (three affected blade sectors) of local surface breakout was found on stages 2, accept and do the borescope inspection in accordance with this Non-Modification Service Bulletin again, at intervals of not more than 25 flight cycles after the previous accomplishment.
- [3] If up to 5,1 percent (three affected blade sectors) of local surface breakout was found on stages 3, accept and do the borescope inspection in accordance with this Non-Modification Service Bulletin again, at intervals of not more than 25 flight cycles after the previous accomplishment.
- [4] If up to 5,1 percent (four affected blade sectors) of local surface breakout was found on stages 4, accept and do the borescope inspection in accordance with this Non-Modification Service Bulletin again, at intervals of not more than 25 flight cycles after the previous accomplishment.
- (c) If more local surface breakout (described in Figure 3, Sheet 2) than accepted above was found on stages 1 to 4, reject the engine
- [1] Provide also the completed Tables 1 to 5 together with a video-copy of the borescope inspection to Rolls-Royce Deutschland, Service Engineering.
- (d) If partial liner loss (described in Figure 3, Sheet 3) and/or complete liner loss (described in Figure 3, Sheet 4) was found on any stage of stages 1 to 4, reject the engine
- [1] Provide also the completed Tables 1 to 5 together with a video-copy of the borescope inspection to Rolls-Royce Deutschland, Service Engineering.

Printed in Great Britain



BR700 Series

SERVICE
BULLETIN

- (e) If open circumferential split line condition without Liner Lifting (with or without cracking and with or without partially rubbing) (described in Figure 3, Sheets 5 and 6) per stage (stages 1 to 4) was found, accept and do the borescope inspection in accordance with this Non-Modification Service Bulletin again, at intervals of not more than 25 flight cycles after the previous accomplishment.
- (f) If open circumferential split line condition with Liner Lifting (with or without cracking and with or without partially rubbing) (described in Figure 3, Sheets 5 and 6) was found on any stage of stages 1 to 4, reject the engine

[1] Provide also the completed Tables 1 to 5 together with a video-copy of the borescope inspection to Rolls-Royce Deutschland, Service Engineering.

- E. In case partial liner loss (described in Figure 3, Sheet 3) on any of the HP compressor stages 1 to 4 front case liners has been found, examine the HP compressor stages 1 to 4 rotor blades in accordance with the Aircraft Maintenance Manual, Chapter 72-00-00, PB601.

NOTE: Examine the HP compressor stages 1 to 4 rotor blades through the borescope access ports B, C and D only, which are already opened for the borescope inspection of the HP compressor stages 1 to 4 front case lining. Deviating from the instruction in the Aircraft Maintenance Manual, do not remove the borescope plug below the Buffer Air Valve (BAV) or any borescope plugs other than those already removed for the borescope inspection of the HP compressor stages 1 to 4 front case lining.

- F. Make sure that the work area is clean and clear of tools, equipment and other unwanted materials.
- G. Close the access to the borescope access ports B, C and D on the core engine
 - (1) Install the HP compressor fairings on the core engine (Refer to the Aircraft Maintenance Manual, Chapter 72-03-01, PB401).
 - (2) Install the bypass duct access panels on the engine (Refer to the Aircraft Maintenance Manual, Chapter 72-71-02, PB401).
 - (3) Close the cowl doors (Refer to the Aircraft Maintenance Manual, Chapter 71-10-00, PB201).
- H. Complete the Accomplishment Form on the pages 31 to 33 and send it together with the video-copy of the borescope inspection to Rolls-Royce Deutschland, Service Engineering.



BR700 Series

SERVICE
BULLETIN

- I. A record of accomplishment is required. Rolls-Royce Deutschland suggests to put an entry into the engine log book
- (1) Record the incorporation of Non-Modification Service Bulletin SB-BR700-72-A900726 in the Engine Service Record.
 - (2) Record the incorporation of Non-Modification Service Bulletin SB-BR700-72-A900726 in the Service Record of the Module 33 Log Card.
 - (3) Record the incorporation of Non-Modification Service Bulletin SB-BR700-72-A900726 in the Service Bulletins List of the Module 33 Log Card.

Printed in Great Britain



BR700 Series

SERVICE
BULLETIN

NOTE:

Some details not shown for clarity.

*** NOTE:**

The High Pressure (HP) compressor stages 2 and 3 front case lining borescope access port is shown slightly rotated for clarity.

Printed in Great Britain

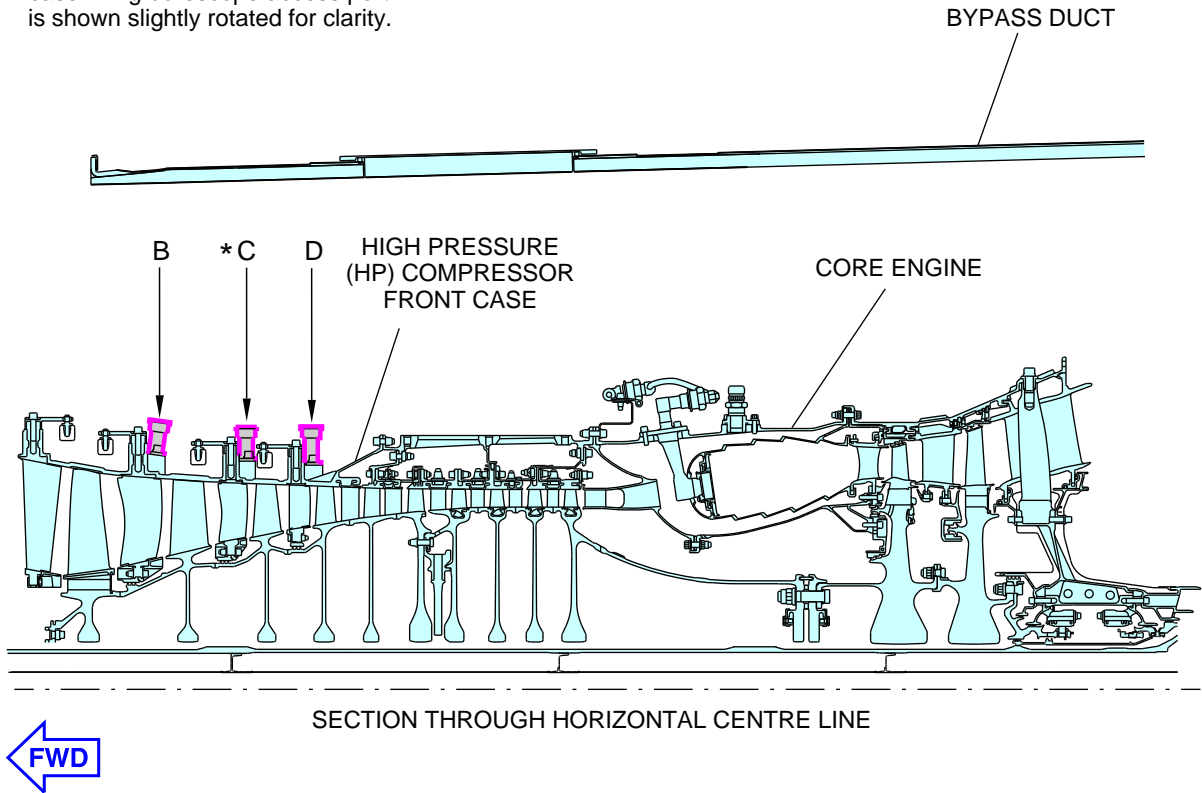

BORESCOPE

ACCESS PORT B – HIGH PRESSURE (HP) COMPRESSOR STAGE 1 FRONT CASE LINING (REAR)
– HIGH PRESSURE (HP) COMPRESSOR STAGE 2 FRONT CASE LINING (FRONT)

BORESCOPE

ACCESS PORT C – HIGH PRESSURE (HP) COMPRESSOR STAGE 2 FRONT CASE LINING (REAR)
– HIGH PRESSURE (HP) COMPRESSOR STAGE 3 FRONT CASE LINING (FRONT)

BORESCOPE

ACCESS PORT D – HIGH PRESSURE (HP) COMPRESSOR STAGE 3 FRONT CASE LINING (REAR)
– HIGH PRESSURE (HP) COMPRESSOR STAGE 4 FRONT CASE LINING (FRONT)

L

bmn7260101

Borescope Access Port Legend
Figure 1



BR700 Series

SERVICE BULLETIN

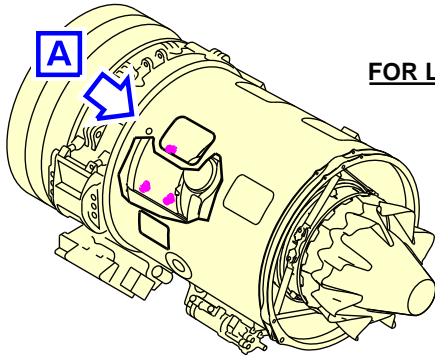

FOR LEFT ENGINES

NOTE:
Some details not shown for clarity.

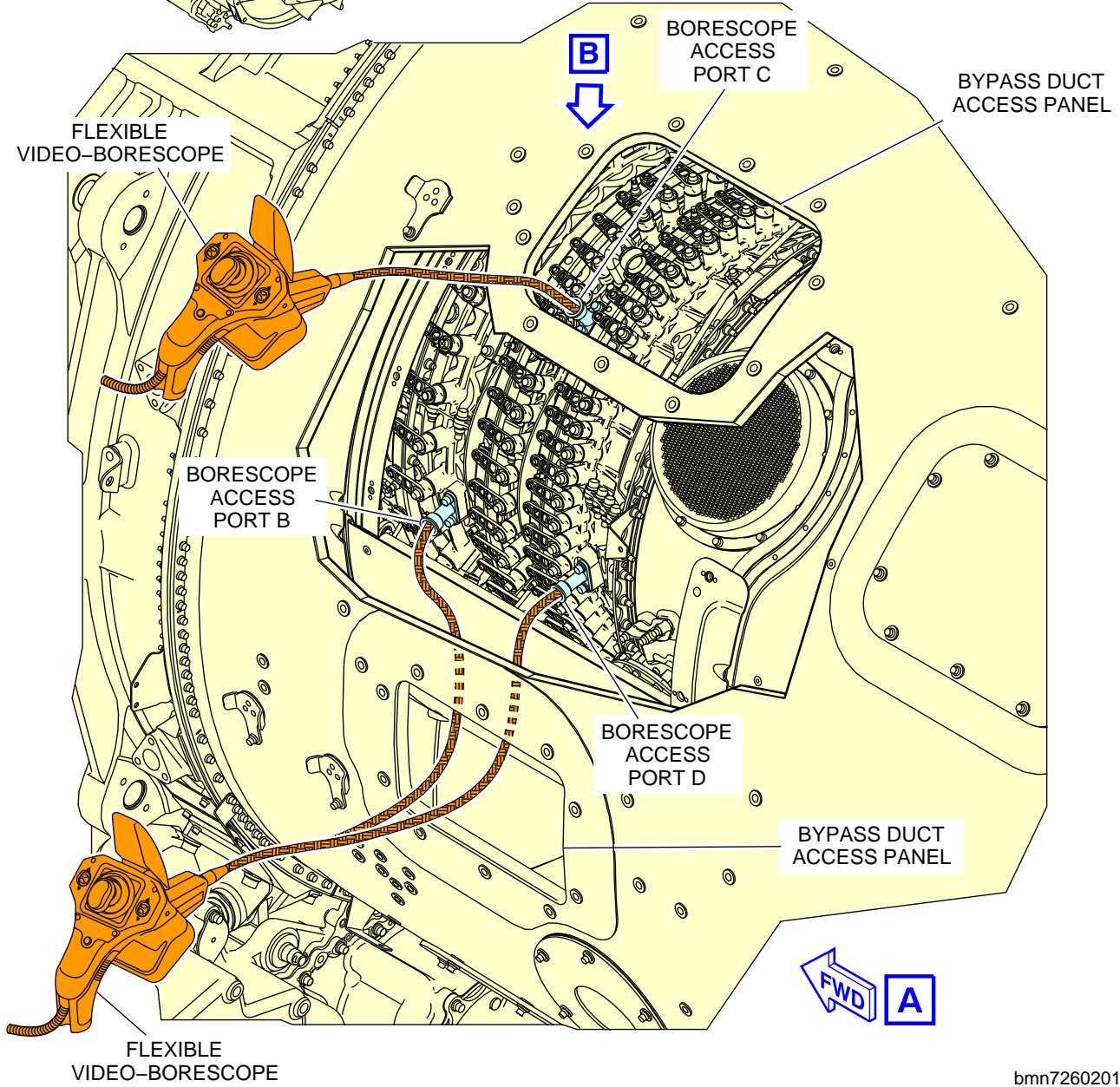

Printed in Great Britain

bmn7260201

Access to the Borescope Access Ports of the HP Compressor Front Case on Left Engines

Figure 2 (Sheet 1 of 7)



BR700 Series

SERVICE BULLETIN

FOR LEFT ENGINES

Printed in Great Britain

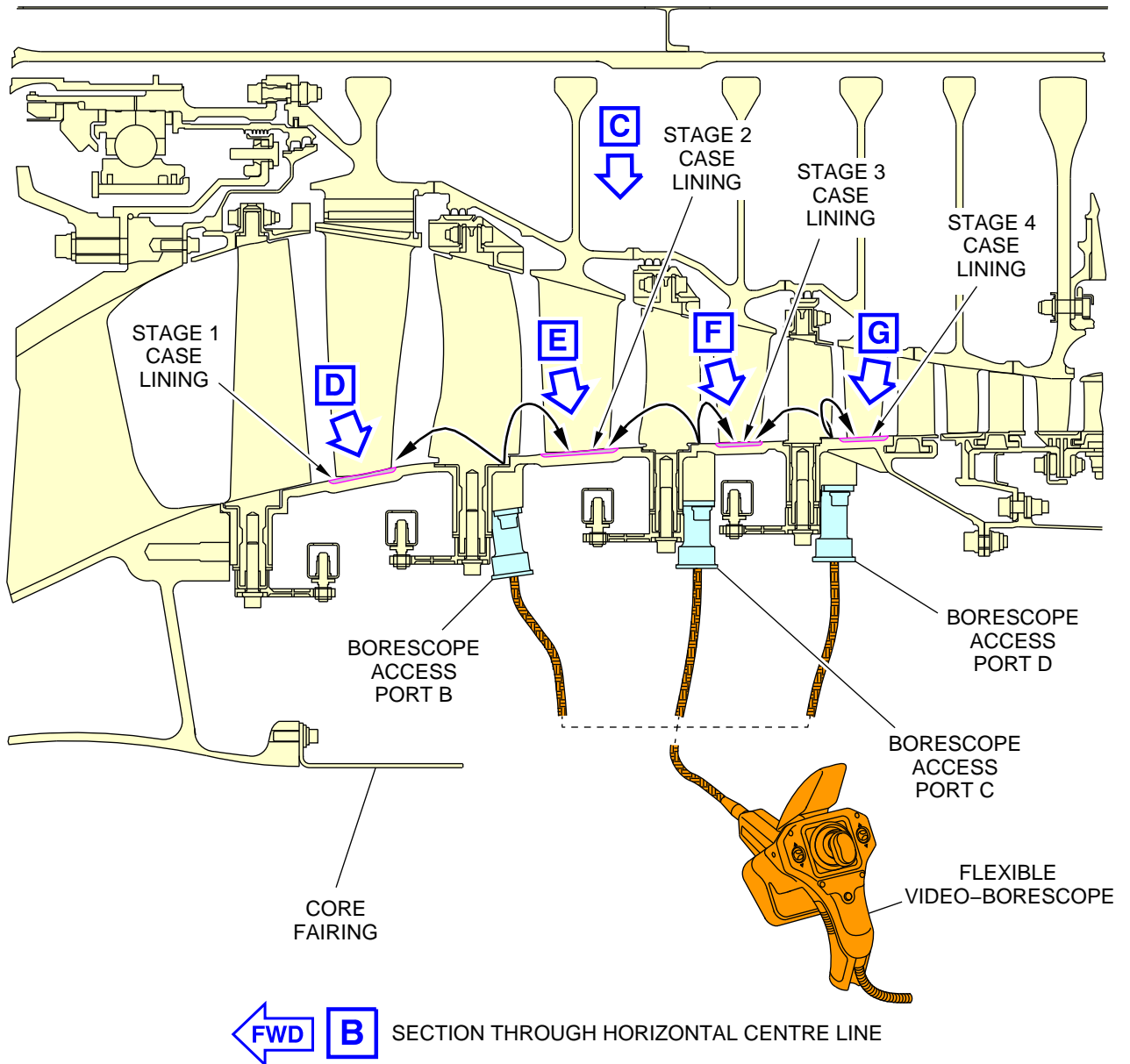

NOTE:
Some details not shown for clarity.

NOTE:
The arrows in this figure are for orientation purposes only. For all case lining inspections, it is required to insert the borescope around the full circumference of the drum.

bmn7260202
Borescope Inspection Paths to the HP Compressor Stages 1 to 4 Front Case Abrasive Lining on Left Engines
Figure 2 (Sheet 2 of 7)



BR700 Series

SERVICE BULLETIN

FOR LEFT ENGINES

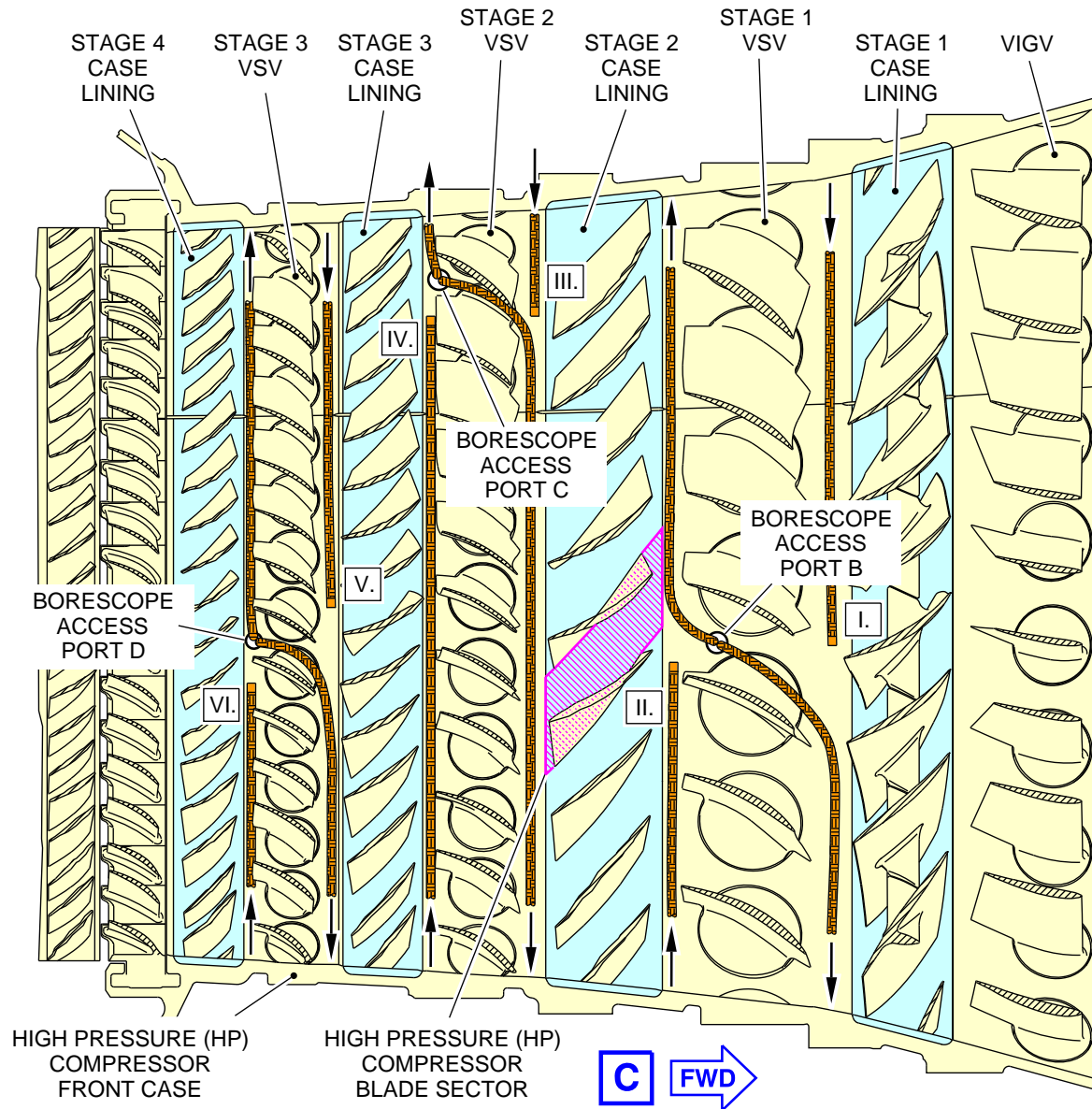

Printed in Great Britain

BORESCOPE ACCESS PORT B

- I. – FOR HIGH PRESSURE (HP) COMPRESSOR STAGE 1 FRONT CASE LINING INSPECTION (REAR)
- II. – FOR HIGH PRESSURE (HP) COMPRESSOR STAGE 2 FRONT CASE LINING INSPECTION (FRONT)

BORESCOPE ACCESS PORT C

- III. – FOR HIGH PRESSURE (HP) COMPRESSOR STAGE 2 FRONT CASE LINING INSPECTION (REAR)
- IV. – FOR HIGH PRESSURE (HP) COMPRESSOR STAGE 3 FRONT CASE LINING INSPECTION (FRONT)

BORESCOPE ACCESS PORT D

- V. – FOR HIGH PRESSURE (HP) COMPRESSOR STAGE 3 FRONT CASE LINING INSPECTION (REAR)
- VI. – FOR HIGH PRESSURE (HP) COMPRESSOR STAGE 4 FRONT CASE LINING INSPECTION (FRONT)

bmn7260203

Borescope Inspection Paths to the HP Compressor Stages 1 to 4 Front Case Abrasive Lining around the circumference of the Front Rotor Drum on Left Engines
Figure 2 (Sheet 3 of 7)



BR700 Series

SERVICE BULLETIN

FOR RIGHT ENGINES

NOTE:
Some details not shown for clarity.

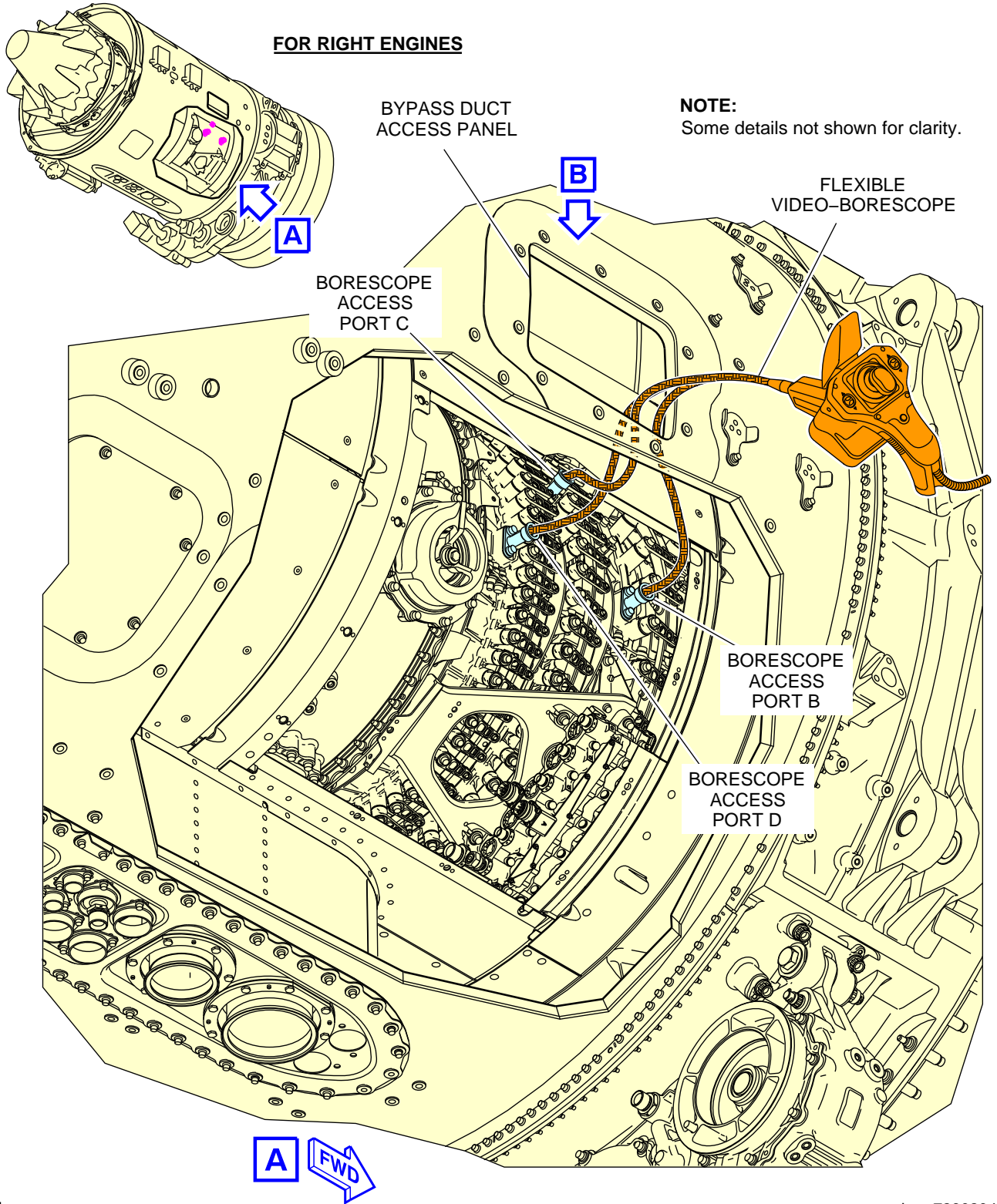

Printed in Great Britain

bm7260204

Access to the Borescope Access Ports of the HP Compressor Front Case on Right Engines

Figure 2 (Sheet 4 of 7)



BR700 Series

SERVICE BULLETIN

FOR RIGHT ENGINES

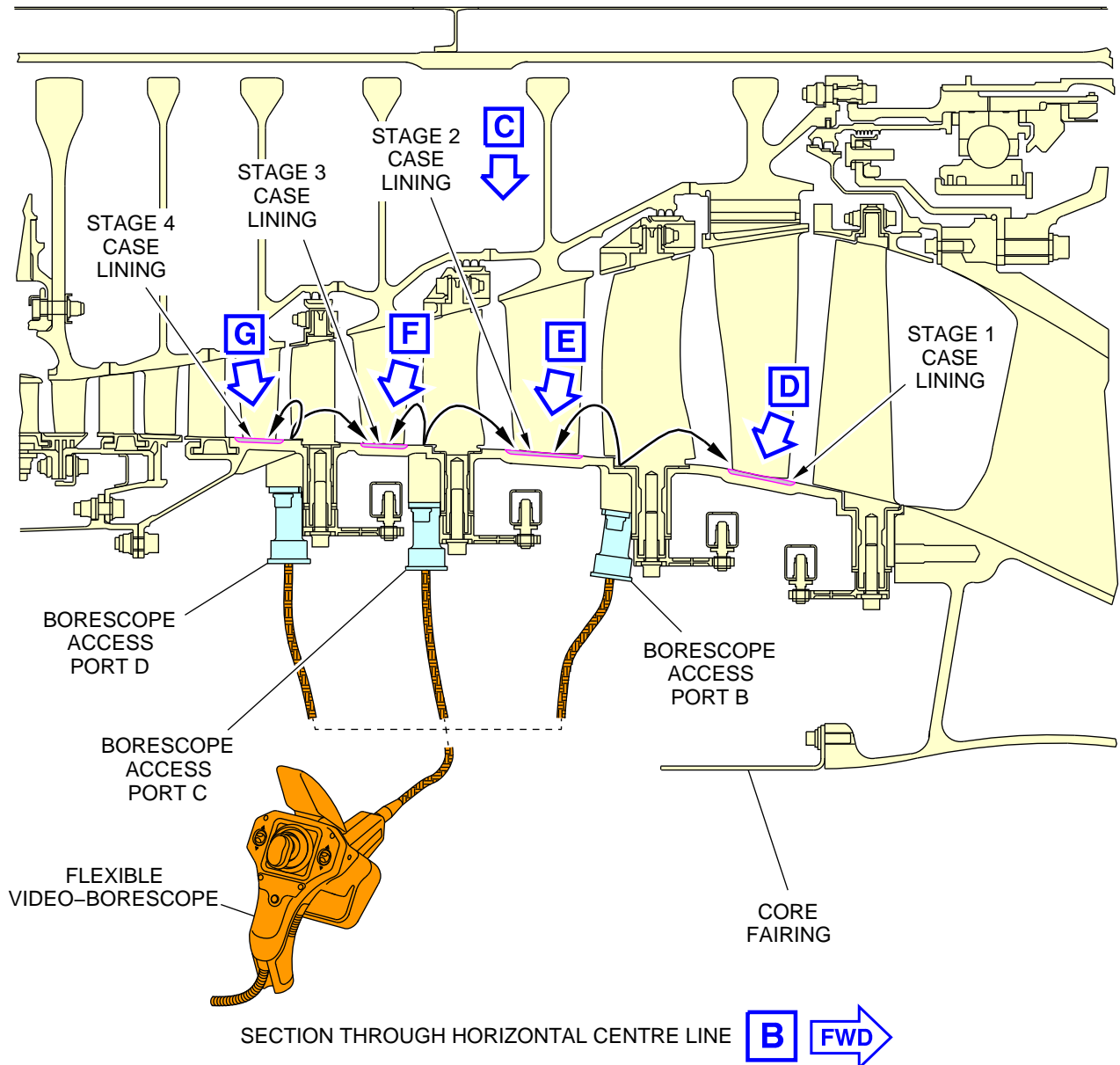

Printed in Great Britain

NOTE:
Some details not shown for clarity.

NOTE:
The arrows in this figure are for orientation purposes only. For all case lining inspections, it is required to insert the borescope around the full circumference of the drum.

Borescope Inspection Paths to the HP Compressor Stages 1 to 4 Front Case Abrasive Lining on Right Engines
Figure 2 (Sheet 5 of 7)



BR700 Series

SERVICE BULLETIN

FOR RIGHT ENGINES

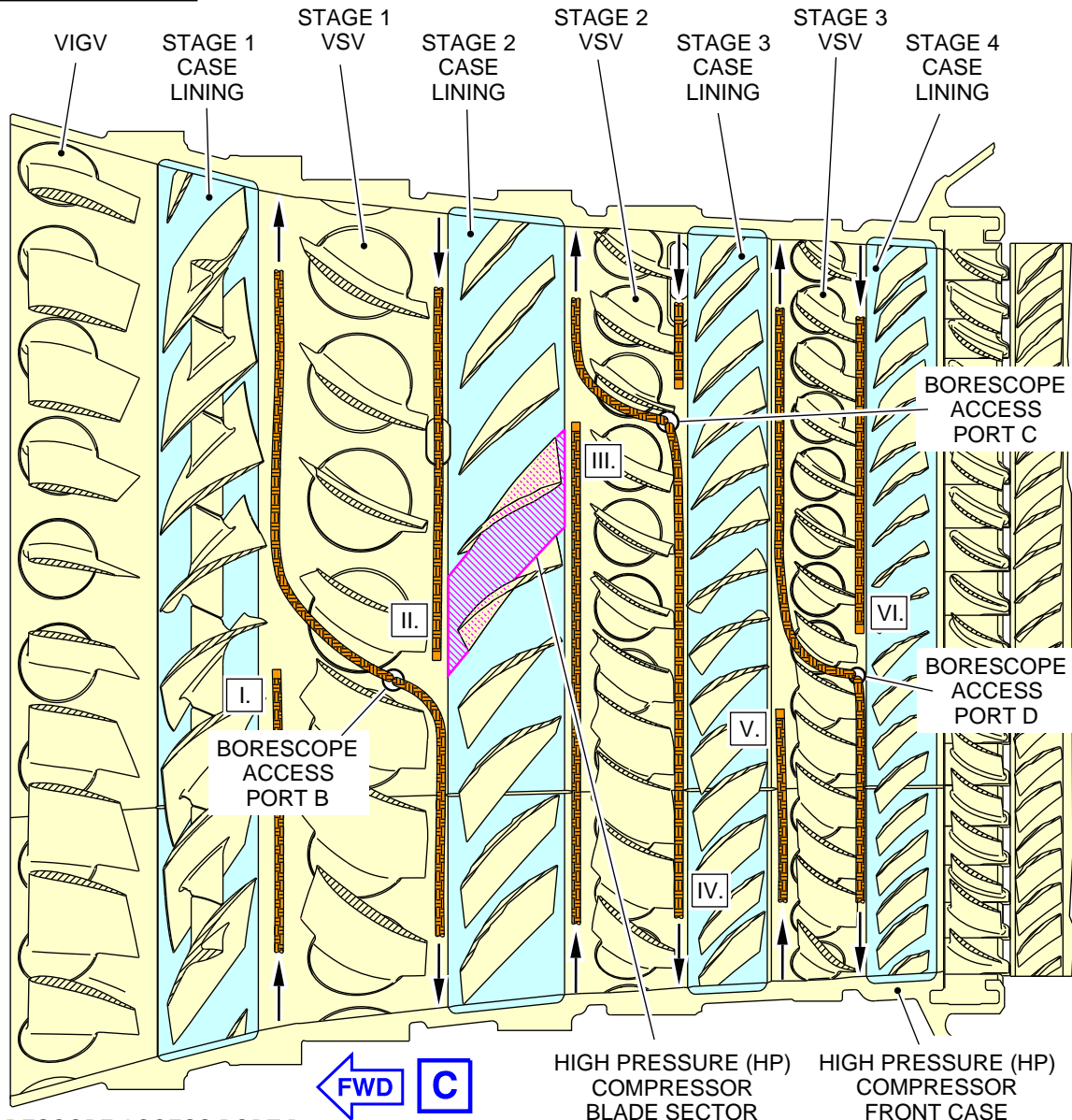

BORESCOPE ACCESS PORT B

- I. – FOR HIGH PRESSURE (HP) COMPRESSOR STAGE 1 FRONT CASE LINING INSPECTION (REAR)
- II. – FOR HIGH PRESSURE (HP) COMPRESSOR STAGE 2 FRONT CASE LINING INSPECTION (FRONT)

BORESCOPE ACCESS PORT C

- III. – FOR HIGH PRESSURE (HP) COMPRESSOR STAGE 2 FRONT CASE LINING INSPECTION (REAR)
- IV. – FOR HIGH PRESSURE (HP) COMPRESSOR STAGE 3 FRONT CASE LINING INSPECTION (FRONT)

BORESCOPE ACCESS PORT D

- V. – FOR HIGH PRESSURE (HP) COMPRESSOR STAGE 3 FRONT CASE LINING INSPECTION (REAR)
- VI. – FOR HIGH PRESSURE (HP) COMPRESSOR STAGE 4 FRONT CASE LINING INSPECTION (FRONT)



bmn7260206

Borescope Inspection Paths to the HP Compressor Stages 1 to 4 Front Case Abrasive Lining around the circumference of the Front Rotor Drum on Right Engines
Figure 2 (Sheet 6 of 7)

Printed in Great Britain



BR700 Series

SERVICE BULLETIN

NORMAL LINER CONDITION: No damages to the liner surface, no breakouts and no liner loss.

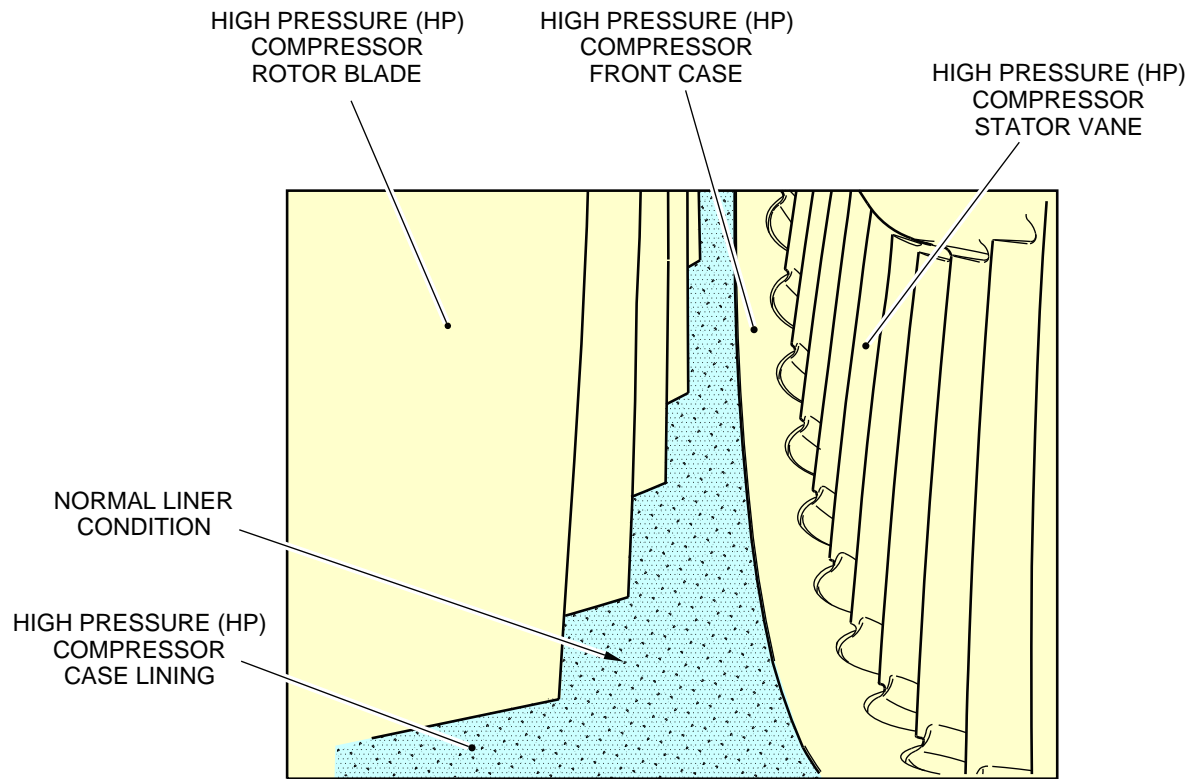

TYPICAL HIGH PRESSURE (HP) COMPRESSOR CASE LINING WITHOUT DAMAGE

TYPICAL VIEW AT DETAILS: **D E F G**

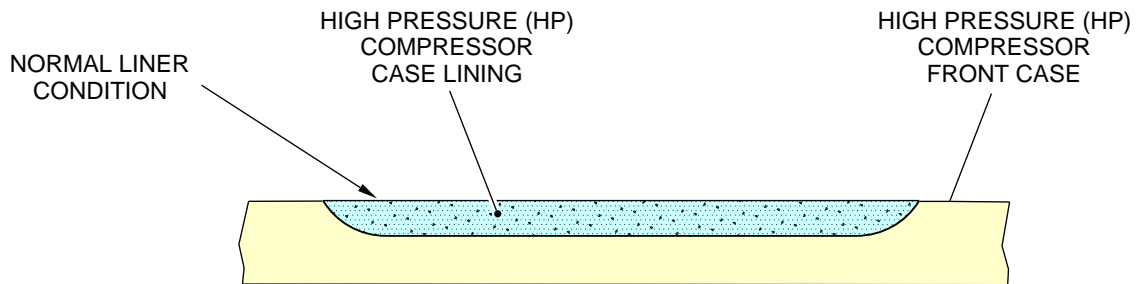

TYPICAL HIGH PRESSURE (HP) COMPRESSOR CASE LINING WITHOUT DAMAGE

Printed in Great Britain

bmn7260207

Borescope Inspection of HP Compressor Stages 1 to 4 Front Case Abrasive Lining
- NORMAL LINER CONDITION -
Figure 2 (Sheet 7 of 7)



BR700 Series

SERVICE BULLETIN

RUBBED CONDITION: Slight longitudinal grooves in circumferential direction at the liner surface only.

Printed in Great Britain

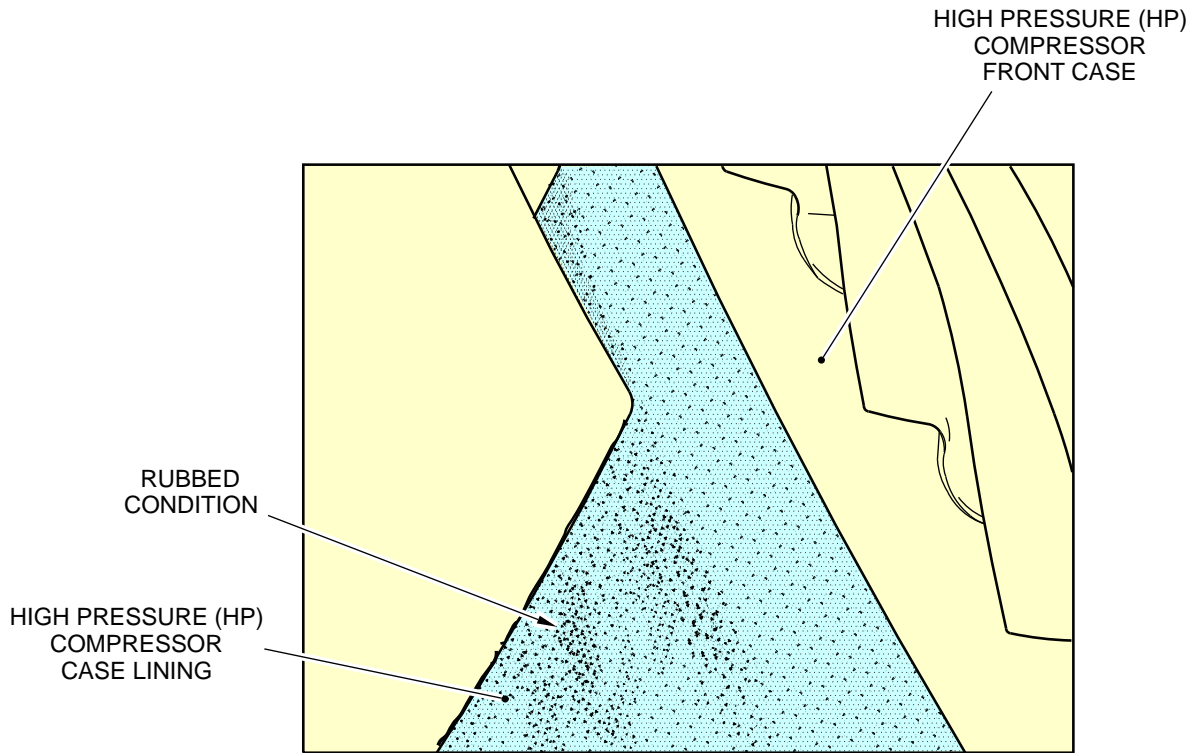

TYPICAL HIGH PRESSURE (HP) COMPRESSOR CASE LINING WITH RUB MARKS

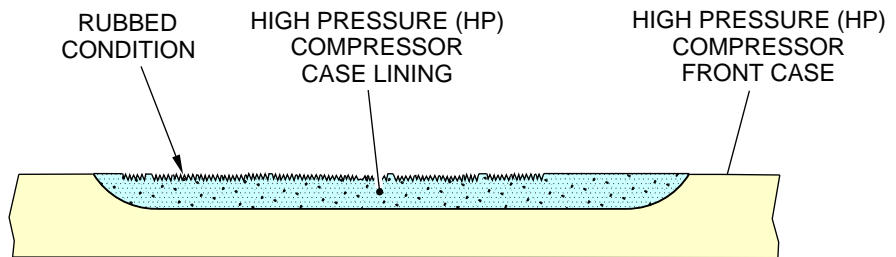

TYPICAL HIGH PRESSURE (HP) COMPRESSOR CASE LINING WITH RUB MARKS

bmn7260301

Borescope Inspection of HP Compressor Stages 1 to 4 Front Case Abrasive Lining
- RUBBED CONDITION -
Figure 3 (Sheet 1 of 6)



BR700 Series

SERVICE BULLETIN

LOCAL SURFACE CHIPPING/PITTING: Local notches, cavities or other impacts at the liner surface only.

LOCAL SURFACE BREAKOUT: Local liner material loss deeper below the liner surface, but not down to the case material at the bottom of the liner pocket.

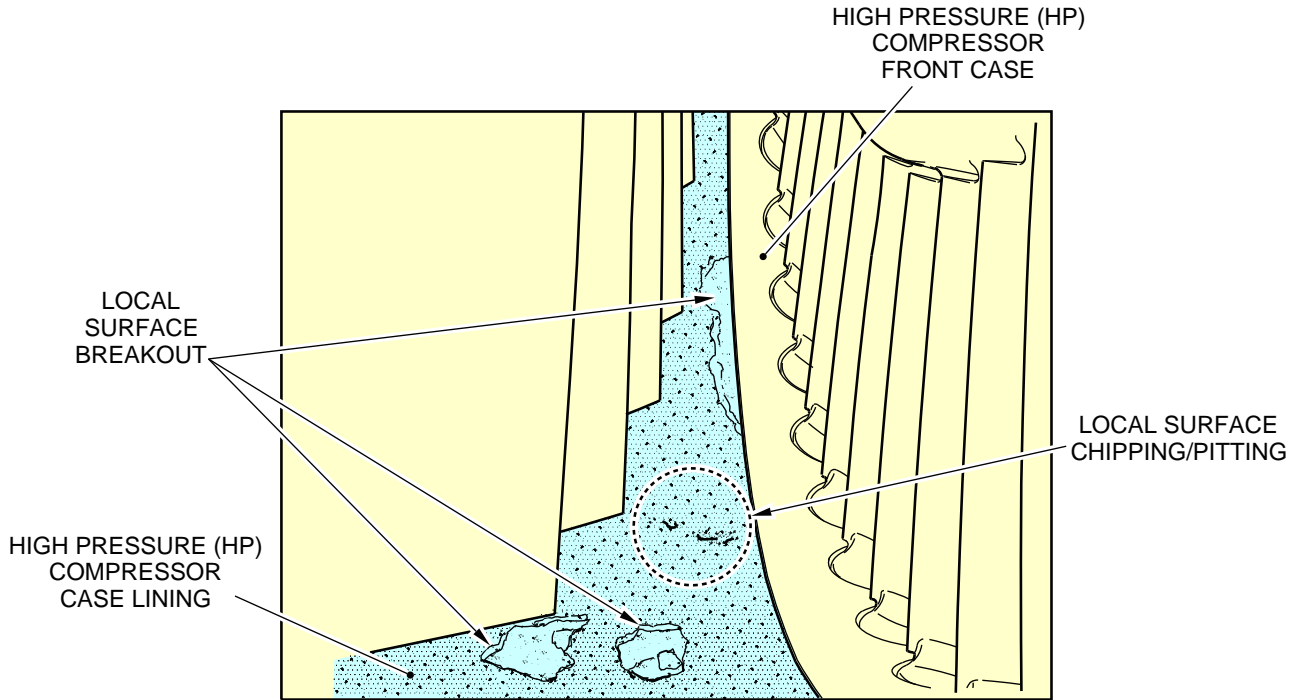

TYPICAL HIGH PRESSURE (HP) COMPRESSOR CASE LINING WITH LOCAL SURFACE CHIPPING/PITTING AND LOCAL SURFACE BREAKOUT

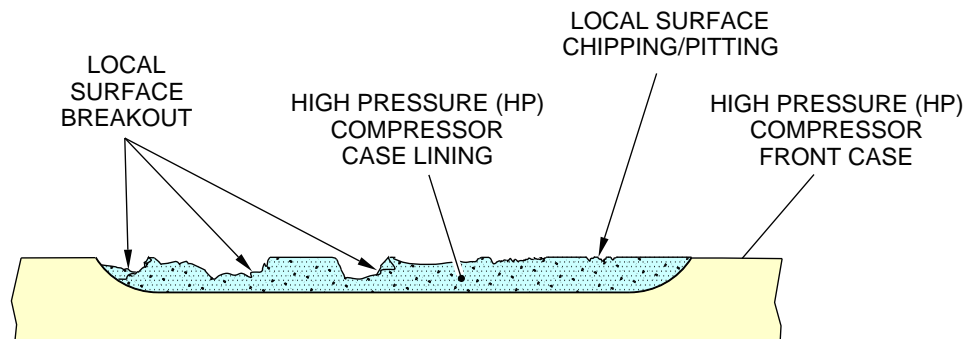

TYPICAL HIGH PRESSURE (HP) COMPRESSOR CASE LINING WITH LOCAL SURFACE CHIPPING/PITTING AND LOCAL SURFACE BREAKOUT

Printed in Great Britain

bmn7260302

Borecope Inspection of HP Compressor Stages 1 to 4 Front Case Abrasive Lining
- LOCAL SURFACE CHIPPING/PITTING / LOCAL SURFACE BREAKOUT -
Figure 3 (Sheet 2 of 6)



BR700 Series

SERVICE BULLETIN

PARTIAL LINER LOSS: Liner material loss down to the case material at the bottom of the liner pocket, but not over the complete liner pocket width from front to rear.

Printed in Great Britain

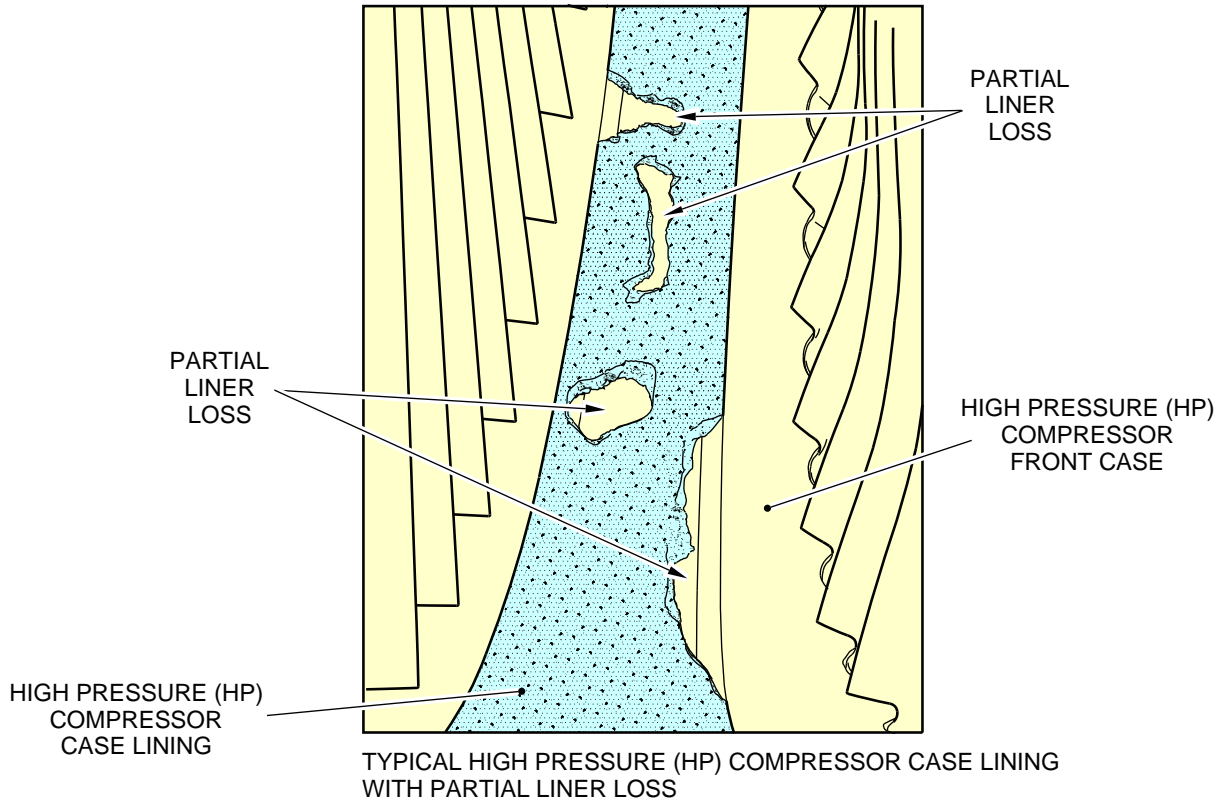

TYPICAL HIGH PRESSURE (HP) COMPRESSOR CASE LINING WITH PARTIAL LINER LOSS

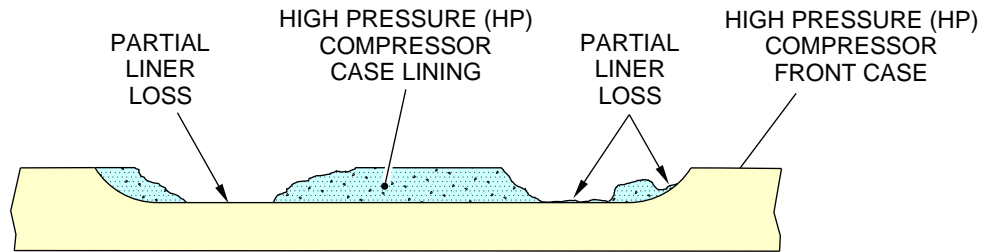

TYPICAL HIGH PRESSURE (HP) COMPRESSOR CASE LINING WITH PARTIAL LINER LOSS

NOTE:
High Pressure (HP)
compressor rotor blades
not shown for clarity.

bmn7260303

Borecope Inspection of HP Compressor Stages 1 to 4 Front Case Abrasive Lining
- PARTIAL LINER LOSS -
Figure 3 (Sheet 3 of 6)



BR700 Series

SERVICE BULLETIN

COMPLETE LINER LOSS: Liner material loss down to the case material at the bottom of the liner pocket, over the complete liner pocket width from front to rear.

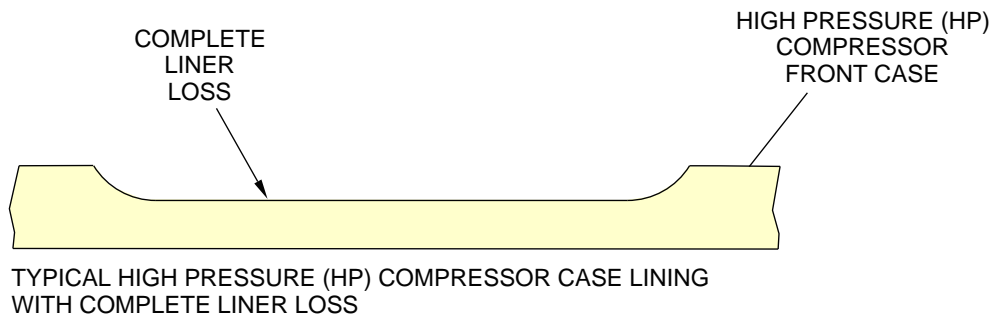
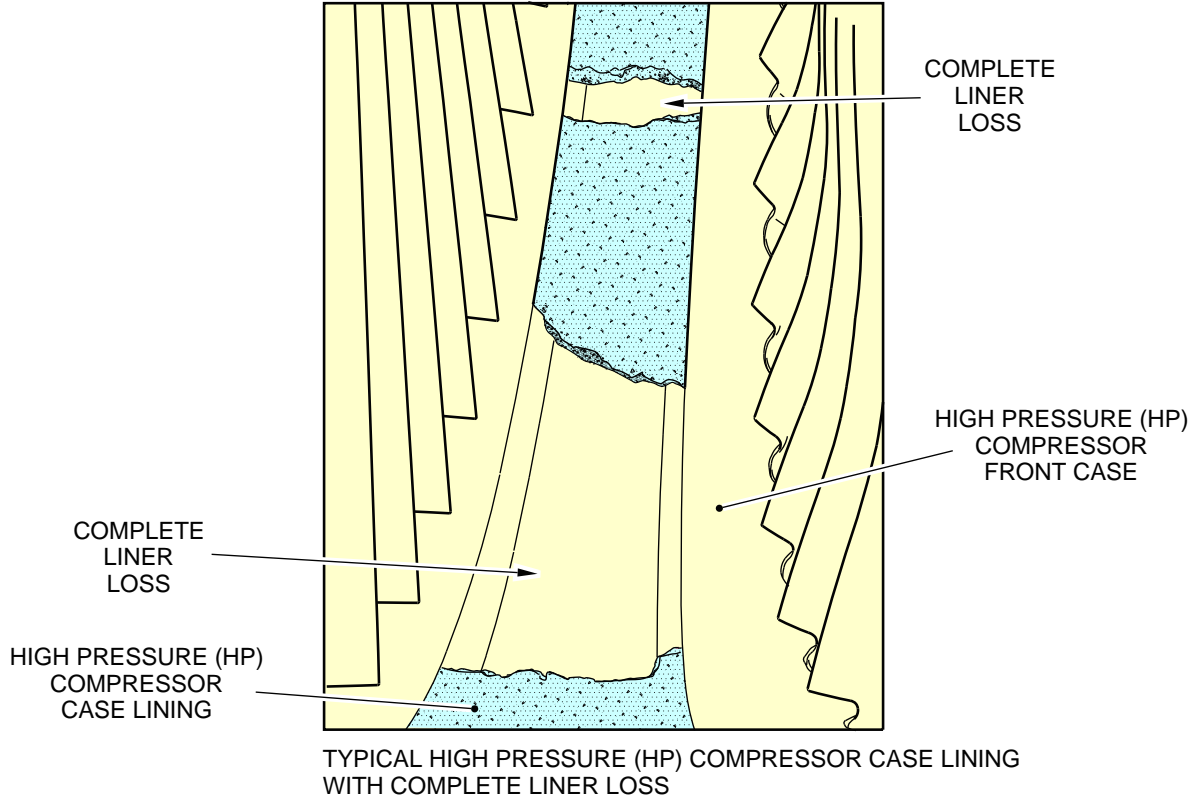

NOTE:
High Pressure (HP) compressor rotor blades not shown for clarity.

Printed in Great Britain

bmn7260304

Borescope Inspection of HP Compressor Stages 1 to 4 Front Case Abrasive Lining
- COMPLETE LINER LOSS -
Figure 3 (Sheet 4 of 6)



BR700 Series

SERVICE BULLETIN

OPEN SPLIT LINE CONDITION: Liner material detachment between the liner and the case in circumferential direction, also with liner lifting and with partially rubbing at the lifted liner.

Printed in Great Britain

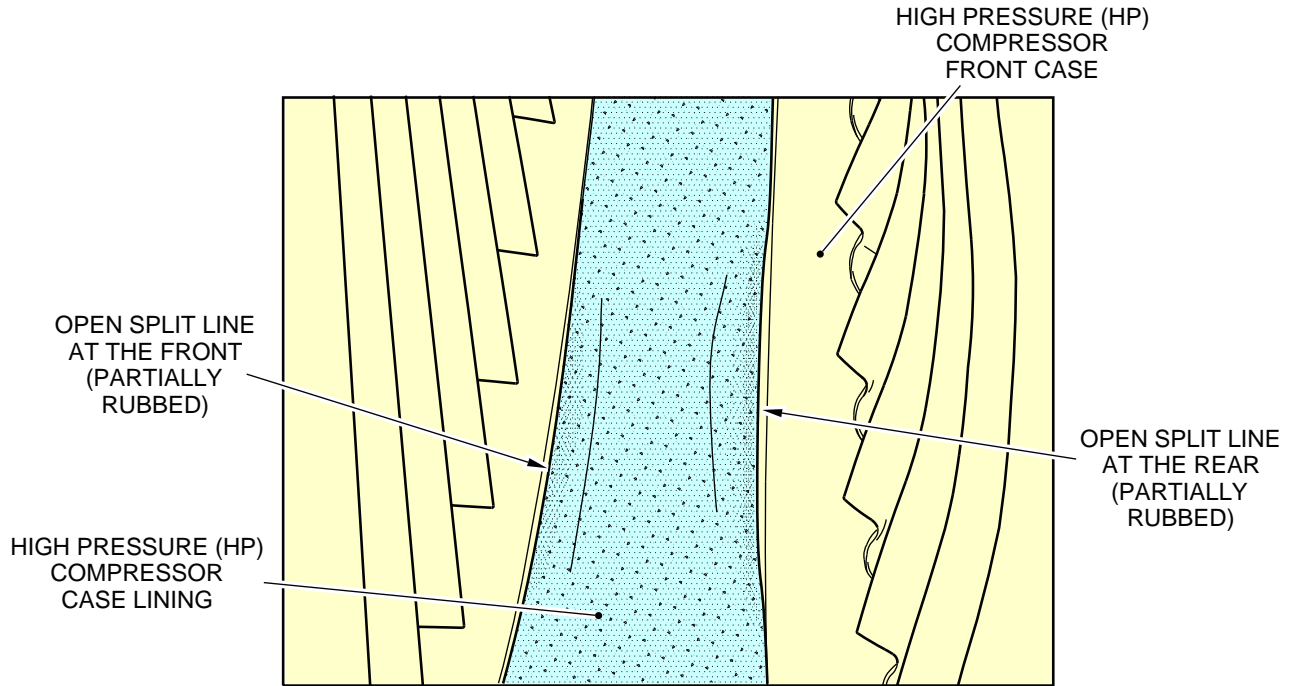

TYPICAL HIGH PRESSURE (HP) COMPRESSOR CASE LINING WITH OPEN SPLIT LINE CONDITION

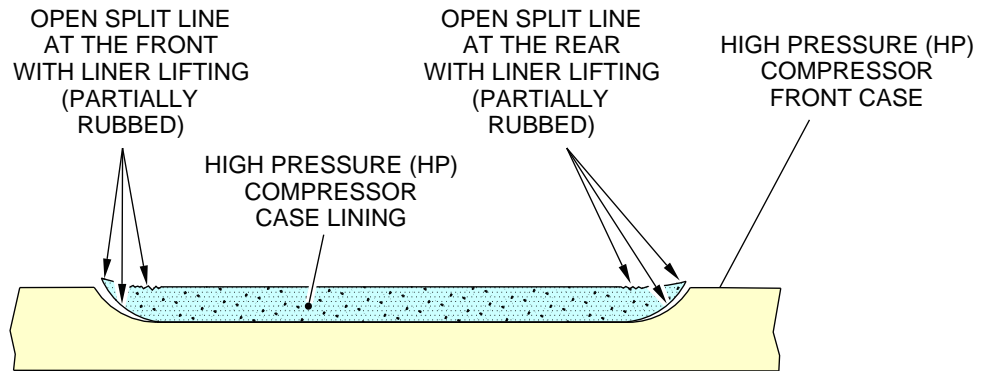

TYPICAL HIGH PRESSURE (HP) COMPRESSOR CASE LINING WITH OPEN SPLIT LINE CONDITION

NOTE:
High Pressure (HP) compressor rotor blades not shown for clarity.

bmn7260305

Borescope Inspection of HP Compressor Stages 1 to 4 Front Case Abrasive Lining - OPEN SPLIT LINE CONDITION -
Figure 3 (Sheet 5 of 6)



BR700 Series

SERVICE BULLETIN

OPEN SPLIT LINE (CRACKING)

AT HALF CASE SPLIT LINE:

Liner material detachment between the liner and the case at the half case split line, also with liner lifting and with partially rubbing at the lifted liner.

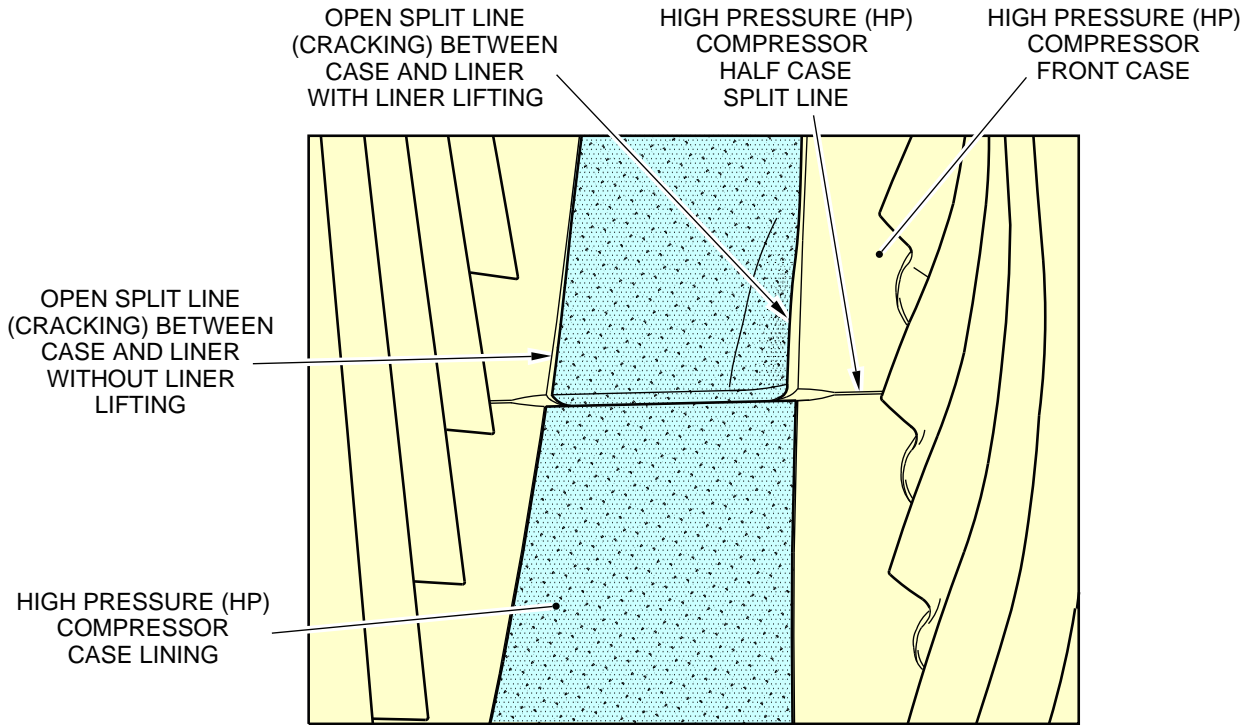

TYPICAL HIGH PRESSURE (HP) COMPRESSOR CASE LINING WITH OPEN SPLIT LINE (CRACKING) BETWEEN CASE AND LINING AT THE HALF CASE SPLIT LINE

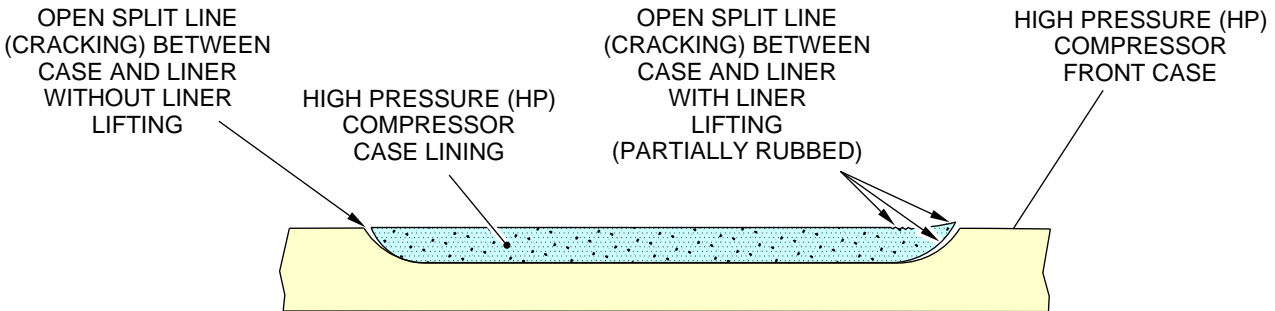

TYPICAL HIGH PRESSURE (HP) COMPRESSOR CASE LINING WITH OPEN SPLIT LINE (CRACKING) BETWEEN CASE AND LINING AT THE HALF CASE SPLIT LINE

NOTE:

High Pressure (HP) compressor rotor blades not shown for clarity.

Printed in Great Britain

bmn7260306

Borecope Inspection of HP Compressor Stages 1 to 4 Front Case Abrasive Lining - OPEN SPLIT LINE (CRACKING) AT HALF CASE SPLIT LINE - Figure 3 (Sheet 6 of 6)



BR700 Series

SERVICE
BULLETIN

AIRCRAFT SERIAL NUMBER	OPERATOR	ACCOMPLISHMENT DATE
		DD.MM.YY:
ENGINE SERIAL NUMBER	ENGINE TIME SINCE NEW (TSN)	ENGINE CYCLES SINCE NEW (CSN)

TABLE 1: BORESCOPE INSPECTION RECORD TABLE

CASE LINING	NORMAL CONDITION	RUBBED CONDITION	LOCAL SURFACE CHIPPING / PITTING	LOCAL SURFACE BREAKOUT	PARTIAL LINER LOSS	COMPLETE LINER LOSS	OPEN SPLIT LINE CONDITION EVIDENT (FRONT/REAR)	
							FRONT	REAR
STAGE 1								REAR
STAGE 2							FRONT	REAR
STAGE 3							FRONT	REAR
STAGE 4							FRONT	

NOTE:

Record all findings with a "tick" or "YES"/"NO" in Table 1.

Printed in Great Britain

bmn7260401

Accomplishment Form
(Sheet 1 of 3)



BR700 Series

SERVICE BULLETIN

TABLE 2: CALCULATION OF THE ACTUAL PERCENTAGE OF LOCAL SURFACE BREAKOUT PER STAGE

HP COMPRESSOR STAGE	TOTAL NUMBER OF BLADE SECTORS PER STAGE	PERCENTAGE OF LOCAL SURFACE BREAKOUT PER BLADE SECTOR	NUMBER OF COUNTED BLADE SECTORS WITH LOCAL SURFACE BREAKOUT	ACTUAL PERCENTAGE OF LOCAL SURFACE BREAKOUT PER STAGE (0 if no findings)
1	31	3.20 % (A)	A x 3.20 =%
2	38	2.60 % (B)	B x 2.60 =%
3	60	1.65 % (C)	C x 1.65 =%
4	79	1.25 % (D)	D x 1.25 =%

NOTE:

If local surface breakout is found – complete Table 2.

TABLE 3: CALCULATION OF THE ACTUAL PERCENTAGE OF PARTIAL LINER LOSS PER STAGE

HP COMPRESSOR STAGE	TOTAL NUMBER OF BLADE SECTORS PER STAGE	PERCENTAGE OF PARTIAL LINER LOSS PER BLADE SECTOR	NUMBER OF COUNTED BLADE SECTORS WITH PARTIAL LINER LOSS	ACTUAL PERCENTAGE OF PARTIAL LINER LOSS PER STAGE (0 if no findings)
1	31	3.20 % (A)	A x 3.20 =%
2	38	2.60 % (B)	B x 2.60 =%
3	60	1.65 % (C)	C x 1.65 =%
4	79	1.25 % (D)	D x 1.25 =%

NOTE:

If partial liner loss is found – complete Table 3.

TABLE 4: CALCULATION OF THE ACTUAL PERCENTAGE OF COMPLETE LINER LOSS PER STAGE

HP COMPRESSOR STAGE	TOTAL NUMBER OF BLADE SECTORS PER STAGE	PERCENTAGE OF COMPLETE LINER LOSS PER BLADE SECTOR	NUMBER OF COUNTED BLADE SECTORS WITH COMPLETE LINER LOSS	ACTUAL PERCENTAGE OF COMPLETE LINER LOSS PER STAGE (0 if no findings)
1	31	3.20 % (A)	A x 3.20 =%
2	38	2.60 % (B)	B x 2.60 =%
3	60	1.65 % (C)	C x 1.65 =%
4	79	1.25 % (D)	D x 1.25 =%

NOTE:

If complete liner loss is found – complete Table 4.

Printed in Great Britain

bmn7260402

Accomplishment Form
(Sheet 2 of 3)

SB-BR700-72-A900726



BR700 Series

SERVICE
BULLETIN

TABLE 5: HIGH PRESSURE (HP) COMPRESSOR HALF CASE SPLIT LINE (CSL) INSPECTION

CASE SPLIT LINE (CSL)	FRONT		REAR	
	OPEN SPLIT LINE (CRACKING) FOUND	LIFTING FOUND	OPEN SPLIT LINE (CRACKING) FOUND	LIFTING FOUND
STAGE 1 INBOARD UPPER CSL *				
STAGE 1 INBOARD LOWER CSL *				
STAGE 1 OUTBOARD UPPER CSL *				
STAGE 1 OUTBOARD LOWER CSL *				
STAGE 2 INBOARD UPPER CSL *				
STAGE 2 INBOARD LOWER CSL *				
STAGE 2 OUTBOARD UPPER CSL *				
STAGE 2 OUTBOARD LOWER CSL *				
STAGE 3 INBOARD UPPER CSL *				
STAGE 3 INBOARD LOWER CSL *				
STAGE 3 OUTBOARD UPPER CSL *				
STAGE 3 OUTBOARD LOWER CSL *				
STAGE 4 INBOARD UPPER CSL *				
STAGE 4 INBOARD LOWER CSL *				
STAGE 4 OUTBOARD UPPER CSL *				
STAGE 4 OUTBOARD LOWER CSL *				

NOTE:

Record all findings with a "tick" or "YES"/"NO" in Table 5.

* Not all Case Split Lines (CSL) are inspectable. Only fill in those boxes for which the inspection area is visible during the borescope inspection – depending on the direction of borescope path.

NON-MODIFICATION SERVICE BULLETIN NMSB-BR700-72-A900726 ACCOMPLISHED	<input type="checkbox"/>	ACCOMPLISHMENT FORM COMPLETED BY: NAME (in capital letters) COMPANY -----
---	--------------------------	---

PLEASE SEND THE COMPLETED ACCOMPLISHMENT FORM TO ROLLS-ROYCE DEUTSCHLAND, SERVICE ENGINEERING, E-MAIL: RRD.SBFEEEDBACK@ROLLS-ROYCE.COM (SUBJECT: NMSB-BR700-72-A900726).

bmn7260403

Accomplishment Form
(Sheet 3 of 3)